

Newcastle University e-prints

Date deposited: 5 February 2010

Version of file: Author final

Peer Review Status: Peer Reviewed

Citation for published item:

Gomes Antunes JM; Mikalsen R; Roskilly AP. [An experimental study of a direct injection compression ignition hydrogen engine.](#) *International Journal of Hydrogen Energy* 2009,**34** 15 6516-6522.

Further information on publisher website:

http://www.elsevier.com/wps/find/journaldescription.cws_home/485/description#description

Publishers copyright statement:

The definitive version of this article, published by Elsevier, 2009 can be viewed at the above website, or via <http://www.sciencedirect.com>.

The definitive version should be used when citing.

Use Policy:

The full-text may be used and/or reproduced and given to third parties in any format or medium, without prior permission or charge, for personal research or study, educational, or not for profit purposes provided that:

- A full bibliographic reference is made to the original source
- A link is made to the metadata record in DRO
- The full text is not change in any way.

The full-text must not be sold in any format or medium without the formal permission of the copyright holders.

**Robinson Library, University of Newcastle upon Tyne, Newcastle upon Tyne.
NE1 7RU. Tel. 0191 222 6000**

An experimental study of a direct injection compression ignition hydrogen engine[☆]

J.M. Gomes Antunes, R. Mikalsen, A.P. Roskilly*

Sir Joseph Swan Institute for Energy Research, Newcastle University, Newcastle upon Tyne, NE1 7RU, England, UK.

Abstract

This paper describes the development of an experimental setup for the testing of a diesel engine in direct injection hydrogen-fuelled mode. Test results showed that the use of hydrogen direct injection in a diesel engine gave a higher power to weight ratio when compared to conventional diesel-fuelled operation, with the peak power being approximately 14% higher. The use of inlet air heating was required for the hydrogen-fuelled engine to ensure satisfactory combustion, and a large increase in the peak in-cylinder gas pressure was observed. A significant efficiency advantage was found when using hydrogen as opposed to diesel fuel, with the hydrogen-fuelled engine achieving a fuel efficiency of approximately 43% compared to 28% in conventional, diesel-fuelled mode. A reduction in nitrogen oxides emissions formation of approximately 20% was further observed.

Key words: hydrogen, engine, compression ignition, direct injection, diesel

1. Introduction

The use of hydrogen (H₂) as a fuel in internal combustion engines has been studied by a number of research groups worldwide in response to increasing governmental pressure and consumer demand for more environmentally friendly fuel chains. Compared with conventional, fossil hydrocarbon fuels, hydrogen offers practically an elimination of pollutants such as carbon monoxide and unburnt hydrocarbons, known to pose health risks in densely populated areas. The only non-trivial pollutant from hydrogen engines is nitrogen oxides (NO_x), however the characteristics of hydrogen fuel, such as a high flame speed and extensive lean-burn operation possibilities, allow significant reductions in NO_x compared to when using conventional fuels. If the generation of hydrogen fuel can be done using renewable energy sources, and other challenges such as storage and transport of hydrogen gas can be solved, the replacing of fossil fuels with renewable sources using hydrogen as an energy carrier may help mitigate the

effects of carbon dioxide emissions on the global environment.

1.1. Hydrogen as a fuel

The majority of internal combustion engine research using hydrogen fuel has focused on pre-mixed charge, spark ignition (SI) engines, and much of this work is driven by the automotive industry [1, 2, 3]. The operation of such engines with high fuel efficiency and low emissions has been demonstrated by a number of researchers. However, due to challenges in hydrogen storage and transport, as well as a missing infrastructure, hydrogen engines have not yet seen widespread commercial success.

Use of hydrogen in pre-mixed homogeneous charge compression ignition (HCCI) mode has also been studied by some authors [4, 5, 6, 7], however the well-documented problems associated with ignition timing control in HCCI engines present operational challenges in such engines. The use of pre-mixed hydrogen in the intake air in diesel engines resolves this problem, since the diesel injection timing can be used to control ignition. This has been studied by a number of authors [8, 9, 10, 11, 12, 13], and such systems have the additional potential advantage that the presence of hydrogen may enhance the combustion of the fuel oil. This allows use of fuels with poor or varying ignition characteristics,

[☆]This is a preprint version. This paper was published as: International Journal of Hydrogen Energy, Volume 34, Issue 15, August 2009, Pages 6516-6522.

*Corresponding author. Tel. +44 191 222 5869; fax +44 191 222 8533.

Email address: tony.roskilly@ncl.ac.uk (A.P. Roskilly)

Preprint submitted to International Journal of Hydrogen Energy

such as bio-oils. However, the requirement for two fuel storage, supply, and injection systems make this concept less suitable for transport applications.

Some operational challenges do also exist for pre-mixed hydrogen engines, which may limit the application of such engines and lead to operational difficulties. Hydrogen has a high autoignition temperature and wide flammability range, making it highly suitable for high-compression lean-burn engines. In addition, a high flame speed prevents engine knock. However, the ignition energy is significantly lower than that of conventional fuels, making hydrogen engines prone to pre-ignition firing, particularly at high loads. A further challenge is that, due to the low density of hydrogen, a stoichiometric hydrogen-air mixture has an energy content approximately 83 per cent of that of a gasoline-air mixture. This reduces the power output of pre-mixed hydrogen engines by typically 30 %, compared to that of gasoline engines, leading to a reduced power to weight ratio in such engines. Moreover, the use of a gaseous fuel requires the development of fuel injection and metering systems, and presents safety issues not present for conventional fuels, including that of inlet manifold back fire.

1.2. Hydrogen direct injection

With hydrogen directly injected into the combustion chamber in a compression ignition (CI) engine, the power output would be approximately double that of the same engine operated in pre-mixed mode. The power output of such an engine would also be higher than that of a conventionally fuelled engine, since the stoichiometric heat of combustion per standard kilogram of air is higher for hydrogen (approximately 3.37 MJ for hydrogen compared with 2.83 MJ for gasoline [1]). Problems associated with inlet air manifold back fire and power de-rating will not occur when using direct injection. There are, however, some challenges associated with the use of hydrogen in a direct injection engine, which are related to the properties of hydrogen. The main challenges are the high self-ignition temperature of hydrogen, the long auto ignition delay, and the high rate of pressure rise. On the other hand, hydrogen has advantageous properties such as a high flame speed, short quenching distance, high heating value, and high diffusivity. In order to improve the hydrogen fuelled CI engine performance, an understanding of the hydrogen combustion mechanism is required, including how operational variables influence the hydrogen ignition and combustion, and how they can be controlled [14].

This paper presents the development of an experimental setup as a research tool for investigations into

the properties of hydrogen as a fuel in direct injection engines, as well as studies of engine performance under such operation. Preliminary test results are presented, showing the basic performance of a DI hydrogen engine and comparing its performance to that of the same engine in conventional diesel-fuelled mode.

2. Research engine and experimental setup

The experimental setup was based around a single cylinder diesel engine, modified to run on hydrogen in direct injection mode. This section describes the laboratory setup, including the development and testing of the hydrogen injection system.

Functionality for pre-mixed compression ignition operation using intake port injection of hydrogen has also been implemented in the system. This gives a flexible research tool allowing experimental studies of a variety of operating modes, including dual fuel operation with hydrogen and diesel fuel. Experimental results from the engine in homogeneous charge compression ignition mode using hydrogen fuel has previously been presented by the authors [4].

2.1. Combustion engine and test rig

The research engine was a modified four-stroke, single cylinder, naturally aspirated, air cooled diesel engine. The main engine specifications are shown in Table 1. Engine operational variables such as gas pressures and temperatures, crank position, exhaust gas emissions, and air mass flows were measured using suitable sensor equipment. The experimental setup is illustrated in Figure 1.

Engine manufacturer	Deutz
Engine model	F1L511
Bore	100 mm
Stroke	105 mm
Swept volume	825 cm ³
Maximum engine speed	3000 rpm
Speed during tests	2100 rpm
Mean piston speed	7.4 m/s
Compression ratio	17:1
Rated power	9000 W

Table 1: Research engine specifications.

The engine was modified to accommodate both port injection and direct injection of hydrogen. This included the development of hydrogen fuel injectors as

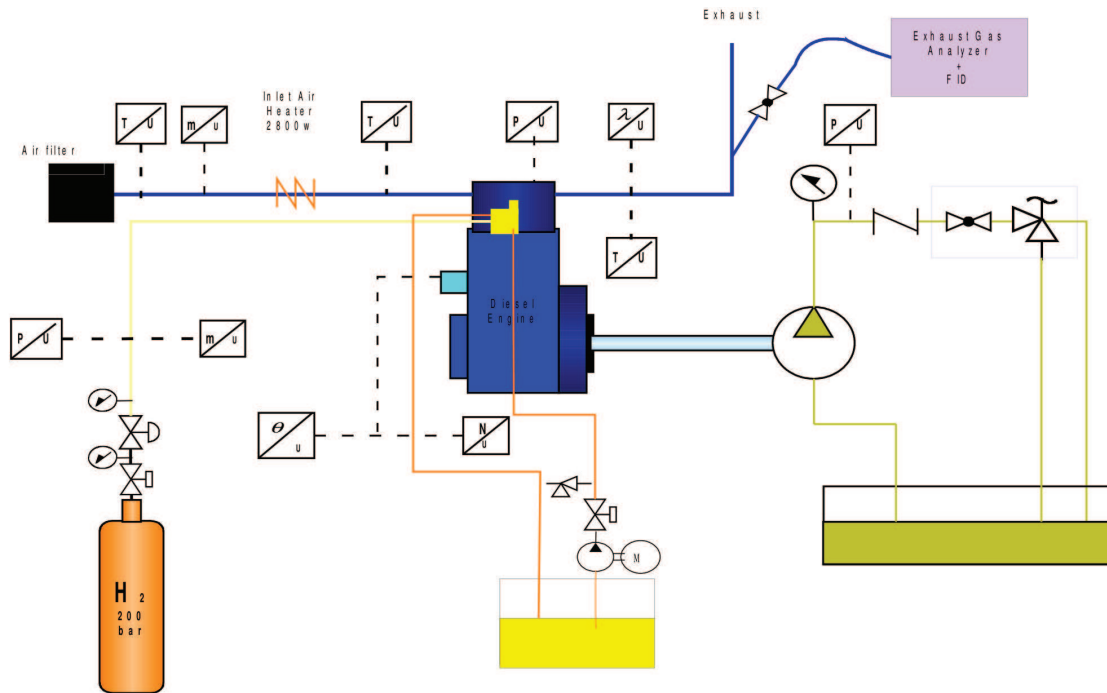

Figure 1: Engine experimental setup.

well as an electronic fuel injection control and timing system, including crankshaft position encoder. The modifications are described in further detail below.

Appropriate safety measures for hydrogen-fuelled operation were implemented in the test rig. This included a lower explosive limit (LEL) transducer installed above the engine to monitor the level of H₂ concentration so that H₂ injection would be disabled if any explosion risk was identified. A vent pipe from the crankcase was installed and connected to the engine inlet manifold and a flame trap was installed in the injection pipe. A gauge was installed in the inlet port, and a quick shut down valve was installed.

The engine is directly coupled to a constant unitary displacement hydraulic pump. The engine load is varied through a hydraulic restriction valve, by varying the discharge pump pressure. The hydraulic system arrangement of the test rig allows a stable load under all engine operating conditions. To perform the brake load calculations, the hydraulic pump compression line is instrumented with a pressure sensor which allows calculation of the engine shaft power. Variation in the hydraulic pump efficiency was considered throughout all operating range, being incorporated into the data acquisition system through a linear regression as a function of the

discharge pressure.

2.2. Hydrogen injection system

A fuel injection system performs two basic functions: fuel pressurisation and fuel metering. When dealing with gaseous fuels, only the metering function is required to be carried out by the injection system as the pressurisation is performed separately. Hydrogen stored at pressures in the order of 200 bar does not require an energy supply (in the form of a fuel pump) to pass the fuel through the nozzle into the combustion chamber. In the experimental set-up, a pressure regulator is fitted in the fuel line, and a needle isolating valve and a flame trap are also inserted before the hydrogen injector.

The main design issues associated with the design of the injector were therefore to optimise the hydrogen flow characteristics and to obtain the required dynamic response to achieve good injection control. As in conventional direct injection engines, the design of the injection nozzle is critical for efficient engine operation, since it controls the way the pressurised hydrogen will spread within the combustion chamber and mix with the air.

2.2.1. Injection system design

Since there are no hydrogen injectors available on the market, the injector used during the research work was developed for this purpose. By assuming that hydrogen behaves as a perfect gas and applying basic compressible flow theory, the flow from the storage tanks to the injector sac volume and nozzle exit can be modelled to obtain initial design guidelines. Since the fuel injection in a direct injection engine occurs in a region of 40 crank angle degrees around TDC, the cylinder pressure against which the injector has to operate may vary from approximately 3 MPa at the start of injection to approximately 8 MPa at the peak pressure conditions, shortly after TDC.

It is interesting to note that due to the low pressure difference between the hydrogen supply and the in-cylinder gas pressure, the flow of fuel from the injector will vary as the cylinder pressure changes. This gives a fuel injection rate profile different to that known from conventional engines, and must be taken into account in the design of the injection system. These characteristics mean that the progress of the combustion process may influence the fuel injection process, and that the effects of fuel injection timing on engine operation and performance are likely to be higher than in conventional diesel engines. Another fact that is important to note is the effect of the increased cylinder air density and viscosity during injection, which can influence the fuel flow through the nozzle exit and the fuel-air mixing within the combustion chamber [3].

Due to these particular operational characteristics, the nozzle flow conditions must be checked for the full range of back pressures possible, and the effects of the variation in in-cylinder gas pressure during the injection period must be taken into consideration in the design of the injection system.

2.2.2. Injector design

To achieve appropriate fast response times required for the hydrogen injector, a fast actuator is required. The injector was therefore designed to be hydraulically actuated and controlled through a three-way fast acting solenoid valve. An external, electric hydraulic pump unit was used to create the required actuation pressure.

Figure 2 shows the injector purposely developed for the experimental facility described in this paper. The injector body was manufactured using construction steel while the needle and nozzle were manufactured using tempered steel. Because hydrogen has a “washing effect” on the lubricating oil, the injector has a Teflon layer on the actuator rod, which is solidly attached to

the nozzle needle. Another undesirable effect of hydrogen on the injector materials is hydrogen embrittlement, calling for highly tempered steel. This effect was observed particularly on the nozzle needle tip, because it works at around 300 °C and the speed of flow is high.

Regarding the Nitrile O-rings used, it was not possible to conclude about the effect of hydrogen, despite that it is known that hydrogen tends to crack rubber pipes. Therefore, the use of special O-ring materials such as

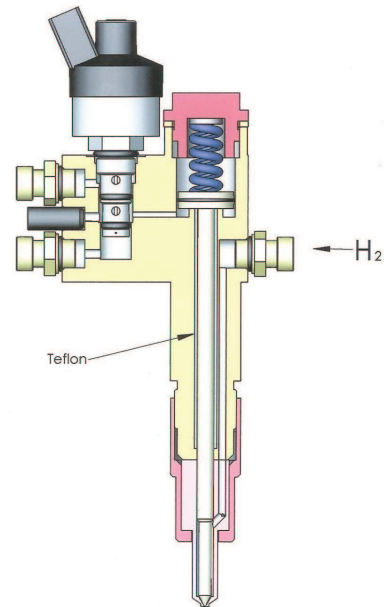

(a) Design drawing.

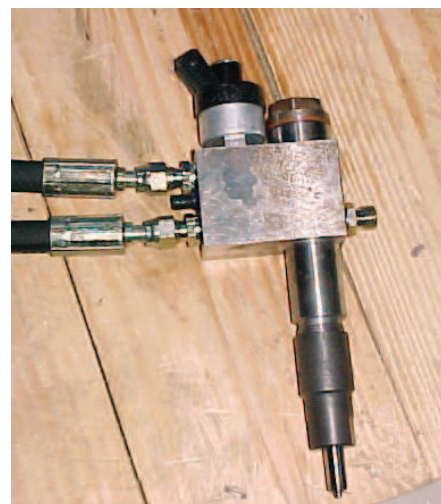

(b) Experimental unit.

Figure 2: Hydrogen fuel injector.

Viton should be considered. Also, low inertia materials, such as titanium, could be employed to achieve better injector dynamic response.

2.2.3. Injection system testing rig

To test the fuel metering and injector dynamic characteristics, as well as the effect of backpressure on the flow rate, an injector testing rig, shown in Figure 3, was developed. The rig consists of a constant-volume chamber, capable of supporting a gas pressure up to 90 bar, with a release valve, a thermocouple and a digital pressure gauge, and a mount point for the injector.

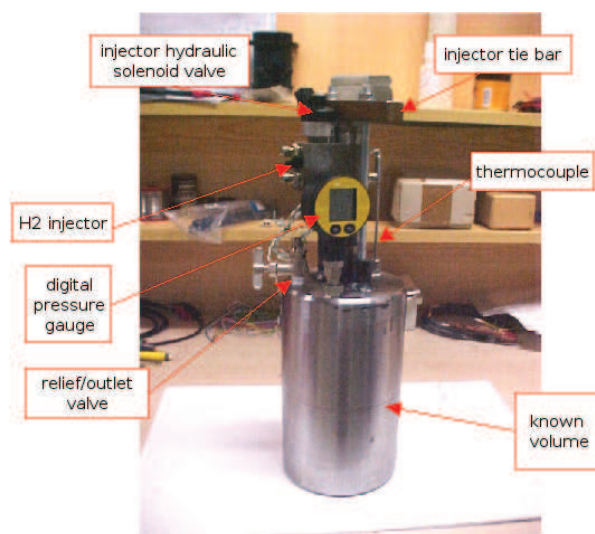

Figure 3: Injector testing rig.

2.3. Inlet air heating system

Due to the high self-ignition temperature of hydrogen, heating of the inlet air may be necessary to ensure fuel autoignition. A 3.5 kW electric inlet air heating system, capable of raising the inlet air temperature to 120 °C, was implemented in the intake system, and the air inlet temperature was controlled using a PID controller. The air heating control system ensures that the correct compression temperature for fuel autoignition is reached, and allows investigations into the influence of this operational variable on the engine performance. The minimum air inlet temperature was found to be 80 °C, since this particular engine compression ratio was limited to 17:1, and this temperature was used in the experiments reported in this paper.

2.4. Data acquisition and engine control system

The engine control system was based on a purpose-built microprocessor controller and specially developed software which allowed variation of various engine operational variables, such as the timing and duration of fuel injection. Engine speed and piston position were monitored via a camshaft encoder, and a combination of commercial and in-house developed software allowed the logging and analysis of data samples.

A real-time data acquisition system was developed to allow engine variables to be monitored, acquired, and analyzed on-line and off-line. The software allows the simultaneous monitoring and acquisition of the following variables: engine brake load; in-cylinder pressure; hydraulic load pressure; hydrogen flow; diesel oil flow; air mass flow; equivalence ratio; air intake temperature; exhaust gas temperature; engine speed; and engine thermal efficiency.

In-cylinder pressure was measured using an Optrand fibre optic sensor, air flow was measured using a Bosch HFM5 hot film mass flow meter (accuracy better than $\pm 3\%$), hydrogen flow was measured using a Dwyer GFM-1107 (accuracy $\pm 1.5\%$). An oxygen ('lambda') sensor type Bosch LSM11 was fitted to monitor exhaust oxygen concentration.

3. Experimental results

A series of tests were conducted to investigate the influence on engine operational variables on the combustion process and engine performance. The tests were conducted at constant engine speed, varying the the excess air ratio and the timing and duration of hydrogen injection.

3.1. Auto-ignition of the hydrogen jet

Based on the work of Tsujimura et al. [3], Figure 4 illustrates the strong dependence of the cylinder charge temperature on the auto ignition delay of the hydrogen jets. It can be seen that for temperatures below approximately 1100 K, the auto ignition delay increases rapidly and becomes significantly longer than for higher temperatures. The auto ignition delay is strongly dependent on the ambient gas temperature, and the temperature dependency follows an Arrhenius function [15].

It was found that for temperatures below 1100 K, the auto ignition delay is longer than that of conventional diesel fuels, but much shorter delays can be obtained if the cylinder charge temperature is close to or above 1100 K. The figure explains the need for inlet air heating in the hydrogen-fuelled engine in order to achieve

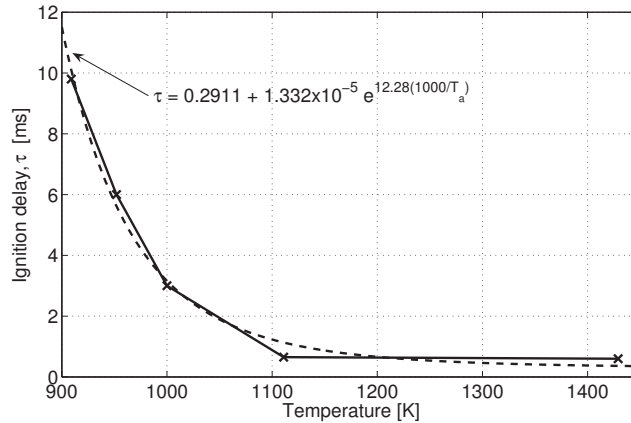

Figure 4: Ignition delay of hydrogen fuel

acceptable ignition delays. For conventional diesel fuels, the ignition delay curve would be shifted to the left due to the lower self-ignition temperatures, and acceptable ignition delay values can be achieved with lower end-of-compression charge temperatures.

3.2. Basic engine performance

With the inlet air heating system, stable engine operation was achieved in hydrogen direct injection mode. Despite a reduced air mass flow through the engine due to the inlet air heating, an increase of more than 14% in peak power was achieved for the hydrogen-fuelled engine compared to conventional diesel operation. This is due to the higher heating value of hydrogen per standard kg of charge air.

Figure 5 shows the in-cylinder gas pressure for one cycle in hydrogen-fuelled mode at full load (the graph is produced by the engine monitoring system). The fast combustion process with a rapid pressure rise can be seen, and a very high peak pressure was obtained, more than 30% higher than when operating in conventional, diesel-fuelled mode, which is due to the high engine power output.

Table 2 shows the engine efficiency results for the different operating modes. Engine efficiency was significantly higher in hydrogen direct injection (DI) mode, with the engine achieving a brake efficiency of 42.8%, compared with 27.9% when using diesel fuel. As can be seen from the table, this is mainly due to lower losses to the cooling system, which constitute engine frictional losses and heat transfer losses, mainly to the combustion chamber walls. The frictional losses are not heavily influenced by the choice of fuel, but the increased

engine power makes the relative influence of the mechanical losses lower in hydrogen-fuelled mode. Reduced in-cylinder heat transfer losses are expected in the hydrogen-fuelled engine due to the properties of the gaseous fuel, leading to enhanced fuel-air mixing, thereby reducing peak gas temperatures, and the lower inertia of the fuel, reducing the problems associated with spray-wall impingement.

Also shown in the table are results from engine tests using intake port injection of hydrogen fuel, both in dual fuel operation with diesel direct injection, and in homogeneous charge compression ignition (HCCI) mode. Experimental results from the latter tests have previously been reported by the authors [4]. As in DI mode, inlet air heating was required in HCCI mode to ensure ignition, and some degree of cycle-to-cycle variations were experienced due to poor control of the ignition timing. Nevertheless, acceptable operation was obtained for a limited load range. For further details, the reader is referred to [4]. In dual fuel mode, no inlet air heating is required since the diesel fuel ensures ignition. The data in the table are for operation on 20% diesel fuel and 80% hydrogen (on an energy basis). The improved performance when using dual fuels and HCCI compared to conventional diesel engine mode can be seen, and is similar to that reported by other authors.

3.3. Nitrogen oxides emissions formation

The nitrogen oxides emissions from a direct injection hydrogen engine are expected to be lower than those of the engine in conventional, diesel-fuelled mode. This is due to the higher diffusivity and the lower inertia of the injected hydrogen gas compared with diesel fuel,

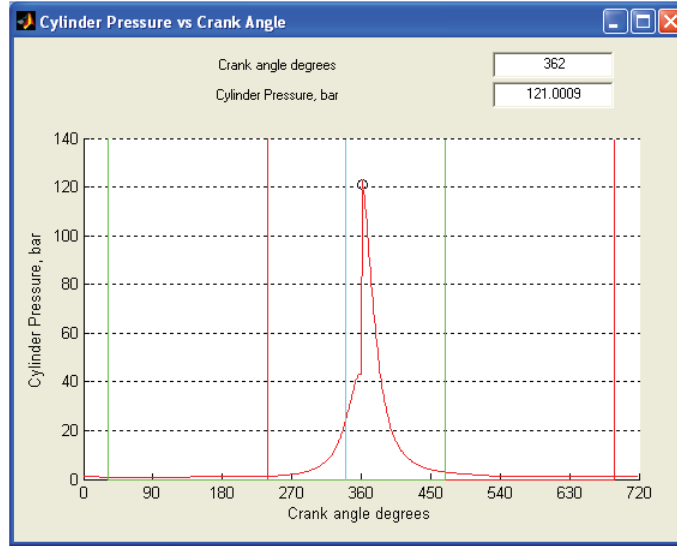

Figure 5: In-cylinder gas pressure plot for one engine cycle in hydrogen direct injection mode.

	Diesel DI	Dual fuel (diesel + H ₂)	H ₂ HCCI	H ₂ DI
Shaft output [%]	27.9	33.9	48.0	42.8
Cooling system [%]	42.2	31.2	20.4	17.3
Exhaust gases [%]	35.3	34.9	31.6	39.9
Shaft power [W]	9000	8950	7076	10280

Table 2: Experimental results for engine energy balance.

enhancing the fuel-air mixing processes after injection. This reduces the local peak temperatures in the combustion chamber.

Nitrogen oxides emissions during the tests were measured using a Testo XL 350 gas analyser with an accuracy of ± 5 ppm, and the measurements were done according to ISO 8178.

Figure 6 shows the measured NO_x emissions with varying engine load for the engine running in hydrogen-fuelled and conventional diesel mode. As expected, the nitrogen oxides formation is low at low loads, for which the cylinder charge is lean and in-cylinder temperatures are lower, but increases sharply with increasing load. A clear NO_x emissions advantage for the hydrogen-fuelled engine can be seen over the full load range, with the NO_x levels being approximately 20% lower than those obtained under diesel-fuelled operation. Although the peak gas pressures are higher in hydrogen-fuelled mode due to the higher fuel burn rate, this is seen not to have an adverse effect on NO_x formation. This suggests that the peak gas temperatures are lower in hydrogen-fuelled mode due to enhanced fuel-air mixing and more ho-

mogeneous conditions within the combustion chamber. High-temperature zones, such as those occurring in the outer regions of the fuel spray in conventional diesel operation are reduced. This is also supported by the results for in-cylinder heat transfer losses presented above.

4. Conclusions

This paper described the development of an experimental setup for the testing of a diesel engine in direct injection hydrogen-fuelled mode. The use of hydrogen direct injection in a diesel engine gave a higher power to weight ratio when compared to conventional diesel-fuelled operation, with the peak power being approximately 14% higher. The use of inlet air heating was required for the hydrogen-fuelled engine to ensure satisfactory combustion, and a large increase in the peak in-cylinder gas pressure was observed. Reduced nitrogen oxides emission formation and a significant efficiency advantage was found when using hydrogen as opposed to diesel fuel, and it was argued that the latter is mainly due to reduced heat transfer and engine frictional losses.

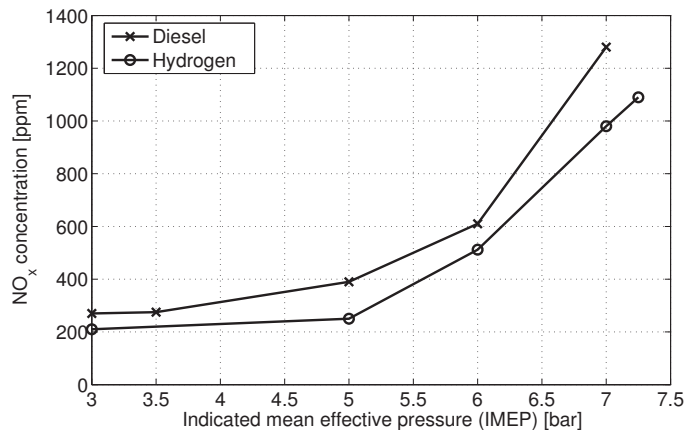

Figure 6: Measured NO_x emissions for hydrogen-fuelled and diesel operation.

The direct injection of hydrogen allows much better control of engine operation compared to when operating in port-injected, HCCI mode. Consideration must be given to the control of injection timing and duration, as these variables heavily influence factors such as rate of pressure rise and maximum combustion pressure. Direct injection offers the possibility to control and limit excessive mechanical loads whilst this is virtually uncontrolled in the HCCI mode of operation.

Further work is needed to develop a reliable hydrogen injector that can produce more accurate control of the fuel injection. Moreover, better results can be obtained if an optimised combustion chamber design is developed specifically for this type of engine, taking into consideration the properties of hydrogen fuel. The presented laboratory setup provides a useful research tool for the study of hydrogen engine performance and optimisation, and further work into these topics are currently underway at Newcastle University.

References

- [1] White CM, Steeper RR, Lutz AE. The hydrogen-fueled internal combustion engine: a technical review. *Int. J. Hydrogen Energy*, 2006;31:1292–1305.
- [2] Peschka W. Hydrogen: The future cryofuel in internal combustion engine. *Int. J. Hydrogen Energy*, 1998;23:27–43.
- [3] Tsujimura T, Mikami S, Achicha N. A study of direct injection diesel engine fueled with hydrogen. SAE Paper 2003-01-0761, 2003.
- [4] Gomes Antunes JM, Mikalsen R, Roskilly AP. An investigation of hydrogen fuelled HCCI engine performance and operation. *Int. J. Hydrogen Energy*, 2008;33:5823–5828.
- [5] Szwaja S, Grab-Rogalinski K. Hydrogen combustion in a compression ignition diesel engine. *Int. J. Hydrogen Energy* (2009), doi:10.1016/j.ijhydene.2009.03.020.

- [6] Noda T, Foster DE. A numerical study to control combustion duration of hydrogen-fueled HCCI by using multi-zone chemical kinetics simulation. SAE Paper 2001-01-0250, 2001.
- [7] Liu C, Karim GA. A simulation of the combustion of hydrogen in HCCI engines using a 3D model with detailed chemical kinetics. *Int. J. Hydrogen Energy*, 2008;33:3863–3875.
- [8] Edwin Geo V, Nagarajan G, Nagalingam B. Studies on dual fuel operation of rubber seed oil and its bio-diesel with hydrogen as the inducted fuel. *Int. J. Hydrogen Energy*, 2008;33:6357–6367.
- [9] Bose PK, Maji D. An experimental investigation on engine performance and emissions of a single cylinder diesel engine using hydrogen as inducted fuel and diesel as injected fuel with exhaust gas recirculation. *Int. J. Hydrogen Energy* (2009), doi:10.1016/j.ijhydene.2008.10.077.
- [10] Masood M, Ishrat MM, Reddy AS. Computational combustion and emission analysis of hydrogendiesel blends with experimental verification. *Int. J. Hydrogen Energy*, 2007;32:2539–2547.
- [11] Senthil Kumar M, Ramesh A, Nagalingam B. Use of hydrogen to enhance the performance of a vegetable oil fuelled compression ignition engine. *Int. J. Hydrogen Energy*, 2003;28:1143–1154.
- [12] Saravanan N, Nagarajan G, Kalaiselvan KM, Dhanasekaran C. An experimental investigation on hydrogen as a dual fuel for diesel engine system with exhaust gas recirculation technique. *Renewable Energy*, 2008;33:422–427.
- [13] Saravanan N, Nagarajan G, Sanjay G, Dhanasekaran C, Kalaiselvan KM. Combustion analysis on a DI diesel engine with hydrogen in dual fuel mode. *Fuel*, 2008;87:3591–3599.
- [14] Verhelst S, Sierens R. Hydrogen engine-specific properties. *Int. J. Hydrogen Energy*, 2001;26:987–990.
- [15] Naber JD, Siebers DL. Hydrogen combustion under diesel engine conditions. *Int. J. Hydrogen Energy*, 1998;23:363–371.