



The 9th International Conference on Applied Energy – ICAE2017

Investigation of a novel composite sorbent for improved sorption characteristic

Long Jiang^{a,b}, Yiji Lu^{b,*}, Ke Tang^b, Anthony Paul Roskilly^b,
Yaodong Wang^a, Ye Yuan^a, Ruzhu Wang^a, Liwei Wang^a

^a Institute of Refrigeration and Cryogenics, Shanghai Jiao Tong University, Shanghai, 200240, China

^b Sir Joseph Swan Centre for Energy Research, Newcastle University, Newcastle NE1 7RU, UK

Abstract

Novel composite sorbents are developed. Strontium chloride (SrCl₂) is selected whereas expanded natural graphite and nanoparticle i.e. carbon coated nickel are integrated as the additive with different densities for the better heat transfer and sorption performance. Thermal properties such as thermal diffusivity and conductivity are investigated by the laser flash method. The sorption performance is tested by the unit which is especially designed. It is indicated that the highest thermal diffusivity could reach 2.242 mm²·s⁻¹ when the density is 1000 kg·m⁻³ and testing temperature is 20 °C. For different testing temperature and density, the thermal diffusivity range from 1.3 mm²·s⁻¹ to 2.242 mm²·s⁻¹. Also worth noting that the highest thermal conductivity could reach 2.5 mm²·s⁻¹ for the environmental temperature. One paramount factor i.e. the global conversion rate of the novel composite SrCl₂ is compared and analyzed under different working conditions. It can be found that the higher desorption temperature results in the faster variation of the global conversion rate. In addition, It takes about 15 minutes and 40 minutes to finish the reaction SrCl₂ 8-1 and 1-0 when the desorption temperature is 180 °C and 130 °C, respectively. For sorption process, it is indicated that the global conversion rate varies faster with the increase of the sorption temperature. When the global conversion is 0.7, it takes about 14 to 28 minutes when sorption temperature range from -5 °C to 15 °C.

© 2017 The Authors. Published by Elsevier Ltd.

Peer-review under responsibility of the scientific committee of the 9th International Conference on Applied Energy.

Keywords: Composite sorbent; Carbon coated Nickel; ENG; global conversion rate

* Corresponding author. Tel.: +44 (0) 191 208 4827

E-mail address: yiji.lu@ncl.ac.uk; luyiji0620@gmail.com (Y. Lu)

1. Introduction

Sorption refrigeration has drawn a burgeoning number of attentions since it is regarded as one environmental benign technology, which is characterized as easy to control and utilizing green refrigerants without Ozone Depletion Potential (ODP) and Global Warming Potentials (GWP) [1-3]. One of key parameter for sorption refrigeration is specific cooling power (SCP), which is mainly related with cycle time [4, 5]. The shorter cycle time is, the higher SCP will become, which will result in the better performance and system compactness. To shorten cycle time mainly lies in two parts. One is the heat and mass transfer enhancement [6, 7]. The other is the better sorption kinetic to accelerate the reaction rate [8].

For heat and mass transfer intensification, composite sorbent has been widely investigated. As one major matrix of composite sorbent, expanded natural graphite (ENG) has been extensively investigated for both physical and chemical sorbents [9], which was invented by the Carburet Company in US firstly [10]. Mauran et al. [11] introduced the ENG as a matrix to the consolidated composite sorbent, which demonstrated the better thermal conductivity for the composite metal chlorides. Tian et al. [12] investigated the heat and mass transfer performance for both physical and chemical composite sorbents of activated carbon and CaCl_2 . Results showed that the highest thermal conductivity of the ENG- CaCl_2 and ENG-AC are 1.66 and 2.61 $\text{W}\cdot\text{m}^{-1}\cdot\text{K}^{-1}$, respectively with regard to the different densities and mass ratios of salt. Wang et al. [13] measured the effective thermal conductivity of ENG- $\text{CaCl}_2\text{-nNH}_3$ ($n = 2, 4, 8$) compound sorbent by using hot wire method at a fixed pressure and temperature under ammonia atmosphere, and the values were in range of 7.05-9.2 $\text{W}/(\text{m}\cdot\text{K})$. Tamainot-Telto and Critoph [14, 15] used the steady-state heat source method to test the thermal conductivity of activated carbon, which was up to 0.44 $\text{W}\cdot\text{m}^{-1}\cdot\text{K}^{-1}$. Jiang et al [6, 16] investigated thermal conductivity and permeability of eight different chlorides with ENG, and compared the properties of different consolidated composite sorbents in sorption process. Nonetheless, since the anisotropic thermal conductivity and permeability had been found for compact expanded natural graphite, some testing methods may cause some inaccuracies [17].

For better sorption kinetics, nanoparticles have been regarded as one possible way to improve the working performance of the sorbent, which has been investigated for the sorption reaction. Franco et al. [18] investigated the sorption kinetic of asphaltene by means of nickel oxide nanoparticles with the silica gel as a matrix. Results demonstrated that isothermal sorption reaction rate increased with the increase of the nanoparticles. Later, the sorption reaction rate of asphaltene was accelerated by the other nanoparticles. It was indicated that on nanoparticulated alumina can be effectively shorten the sorption time to 2 minutes, making this sorbent a good candidate [19, 20]. Also for the chemisorption reaction, there are quite a lot of selections for improve the sorption kinetic for the sorption refrigeration[21]. Nonetheless, less concerning researches are reported ENG and nanoparticles as the additives for the sorption refrigeration [17, 22], which is a probably prospective way to improve the system performance from two different aspects.

In this paper, strontium chloride (SrCl_2) impregnated with both ENG and carbon coated nickel as an additive is investigated for thermal properties as well as the sorption characteristics since there is little research work on the performance of this composite sorbent.

2. Materials and characterization

Compared with the conventional composite sorbent, the novelty is to introduce the nanoparticle i.e. carbon coated nickel into the sorbent. The thermochemical reaction process of SrCl_2 with ammonia can be referred to the equations 1-3.

The development of the SrCl_2 composite sorbent can be referred to the

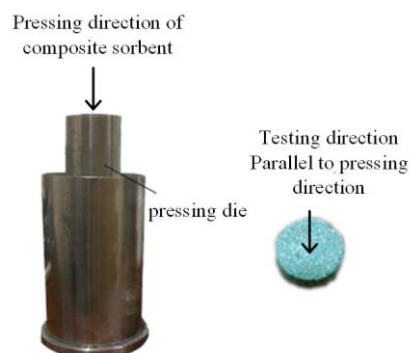

Fig. 1. The pressing rig and sample

reference[23]. ENG is expanded by the optimal expanding process, i.e. heating untreated natural graphite in an oven at the temperature of 600 °C for 8 minutes [21]. First, ENG is dried in the oven with controlled temperature of 120 °C. Meanwhile, the nanoparticle is dispersed in ethanol with ultrasonic bath for 30 minutes to prevent the aggregation of carbon coated nickel in the mixing process. SrCl₂, ENG and carbon are stirred and mixed together by the ultrasonic treatment for another 30 minutes. The mixture will be dried in an oven at 120°C for 48 h. Finally, the mixture is put into a vessel and pressed by a die, which is as shown in Fig.1. The test direction is parallel to the pressing direction.

Mass ratio of salt and density are two major factors in the process of developing SrCl₂ composite sorbent. The higher density and lower mass ratio of salt is, the lower permeability and the higher thermal conductivity becomes. For testing the thermal properties, density is selected in the range of 600 kg·m⁻³-1000 kg·m⁻³ and the mass ratio among SrCl₂, ENG and carbon is 40:20:1.

3 Characterization methods

Thermal diffusivity and thermal conductivity is investigated by the Laser flash measuring method, and type of the instrument is LFA467 produced by Netzsch Company as shown in Fig.2. The Laser flash measuring method is explained as follows. For a certain setting temperature T, a beam of light pulses is emitted instantaneously by the a xenon flash lamp and uniformly illuminating in the sample surface, so that the temperature transient increases as the hot end of the one-dimensional heat conducts to the cold end propagation. The trend of the temperature can be measured by using an infrared detector. By analysing the curves of temperature-versus-time and concerning calculation, thermal conductivity can be determined.

For the ideal case, width of the optical pulse is almost infinitely small. Heat conduction in the interior of the sample is regarded as one-dimensional heat transfer from the lower surface to the upper surface. Through measuring semi-heating time t_{50} (define as the half time required as the temperature of the sample in the upper surface is raised after receiving the light pulse irradiation) by the following formula:

$$\alpha = 0.1388 \times d^2 / t_{50} \quad (4) \quad \text{where } \alpha \text{ is thermal diffusivity, } d \text{ is the thickness of the testing samples, } t_{50} \text{ is the semi-heating time.}$$

$$\lambda(T) = \alpha(T) \times C_p(T) \times \rho(T) \quad (5) \quad \text{where } \lambda(T) \text{ is the thermal conductivity at a certain temperature, } \alpha(T) \text{ is the thermal diffusivity at a certain temperature, } C_p \text{ is specific heat at a certain temperature, } \rho(T) \text{ is the density of the sample at a certain temperature.}$$

The random error of the equipment is less than 0.1%, and the largest relative error is 5%.

The sorption kinetics of the novel sorbent was tested by the test unit shown in Fig.3. The test unit has two sorption beds, one refrigerant vessel, three cryostats, a pressure transmitter and valves, etc. The refrigerant vessel acts as condenser or evaporator, depending on the operation conditions. Temperature of sorption bed and the refrigerant vessel is controlled by two cryostat baths. The testing processes of isobaric sorption/desorption kinetics are as follows:

Sorption process: Open the valves V1 and V3 in Fig.1a. Keep the refrigerant vessel at a constant pressure by low-temperature thermostat bath i.e. thermostat 1, and control the temperature of sorption reactor decreasing from high temperature to environmental temperature slowly. For each test point with predetermined refrigerant



Fig. 2. Photo of the Schematic of thermal conductivity testing unit

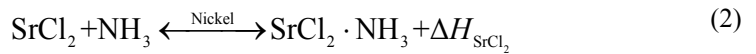
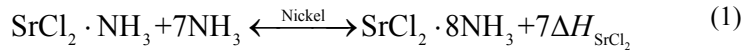

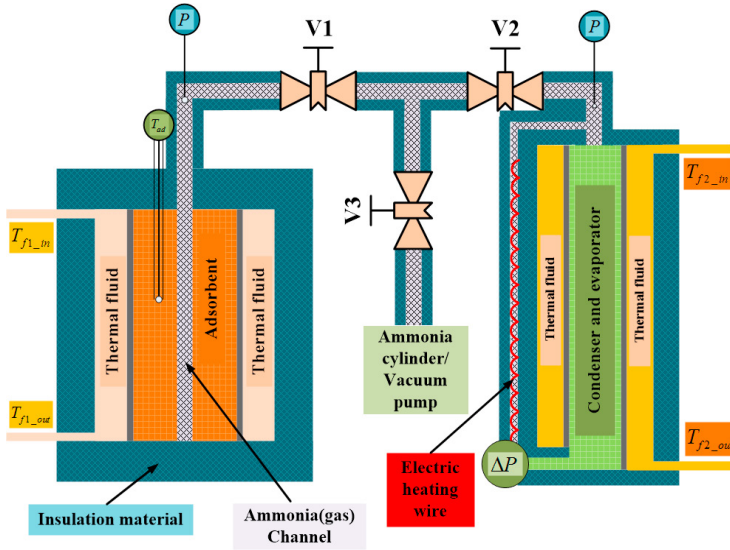

Fig. 3. Test unit of sorption performance [24, 25]

temperature and sorption temperature the fluid level in the refrigerant vessel is recorded by the smart pressure transmitter when the data doesn't change for at least 6 minutes.

Desorption process: By the similar way the reactor is heated from environmental temperature to desorption temperature slowly, and the data of the refrigerant level in the refrigerant vessel is recorded. The sorption quantity of sorbent is calculated by the refrigerant level in the vessel.

Cycle sorption quantities are calculated as Equation 6, where ΔP is the pressure difference for the condensation and evaporation process (Pa), m_{salt} is the sorbent

$$\Delta x = \frac{1}{m_{salt}} \cdot \Delta \left\{ \left(1 - \frac{v'(T_e)}{v'(T_c)} \right) \cdot \frac{A_c}{g} \cdot \Delta P \right\} \quad (6)$$

$$\left| \frac{d\Delta x}{\Delta x} \right| \leq \left| \frac{dm_{salt}}{m_{salt}} \right| + \left[\frac{d \left(\left(1 - \frac{v'(T_e)}{v'(T_c)} \right) \cdot \frac{A_c}{g} \cdot \Delta P \right)}{\Delta \left(\left(1 - \frac{v'(T_e)}{v'(T_c)} \right) \cdot \frac{A_c}{g} \cdot \Delta P + V / v'(T_e) \right)} \right] \quad (7)$$

mass (kg), V is the liquid ammonia volume in the refrigerant vessel (m^3), g is the gravity acceleration (9.80 m/s^2), $v'(T_e)$ is specific volume of saturated liquid ammonia (m^3/kg), A_c is the effective area of cross section of ammonia in the evaporator / condenser (m^2).

The sorbent mass is measured by the balance (BS2202S) with a measuring error of 0.01 g. The pressure difference between the vapor end and liquid end of the evaporator/condenser is tested by the smart differential pressure transmitter, whose testing error is 0.2%. According to Equation 7, the relative error of sorption/desorption quantity and cycle sorption quantity of novel sorbent are 0.37%.

4 Performance of different sorbents

4.1. Thermal diffusivity

Fig.4 shows the thermal diffusivity of the novel composite sorbent with different densities for testing temperature. It is indicated that the thermal diffusivity increases with the decrease of testing temperature and the increase of the density. This is mainly because the higher temperature results in that the novel sorbent becomes friable, which leads to the larger thermal contact resistance.

The highest thermal diffusivity is able to reach $2.242 \text{ mm}^2 \cdot \text{s}^{-1}$ when the density is $1000 \text{ kg} \cdot \text{m}^{-3}$ and testing temperature is 20°C . For different testing temperature and densities, the thermal diffusivity

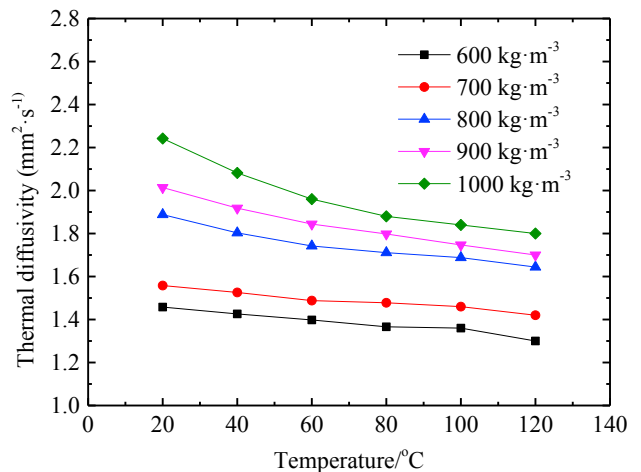

Fig. 4. Thermal diffusivity vs. different density and temperature

ranges from $1.3 \text{ mm}^2 \cdot \text{s}^{-1}$ to $2.242 \text{ mm}^2 \cdot \text{s}^{-1}$.

4.2. Thermal conductivity

Since thermal conductivity for different testing temperature shows the similar trends, environmental temperature is selected as one example for further elaboration. Fig.4 shows the thermal diffusivity of the novel composite sorbent with different density when the testing temperature is 20°C. As it shows, the highest thermal conductivity could reach $1.345 \text{ W} \cdot \text{m}^{-1} \cdot \text{K}^{-1}$. For different density, the thermal conductivity ranges from $0.5 \text{ W} \cdot \text{m}^{-1} \cdot \text{K}^{-1}$ to $1.345 \text{ W} \cdot \text{m}^{-1} \cdot \text{K}^{-1}$.

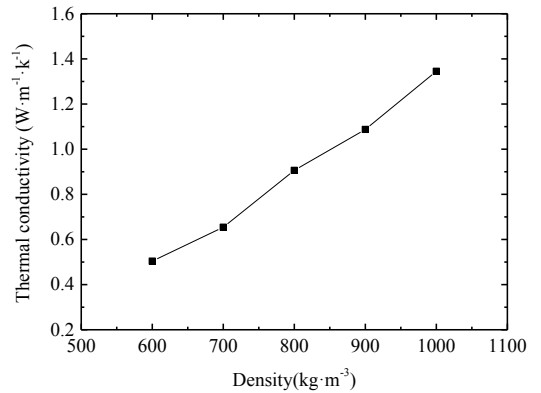

Fig. 5. Thermal conductivity for different density

4.3. Sorption characteristic of composite sorbent

The global conversion rate is defined as the percentage of composite sorbent that reacted with the refrigerant, which is a key parameter to assess the working performance of sorption refrigeration system[26]. For different sorption and desorption temperature, the global conversion rate of the novel composite SrCl₂ is compared and analyzed which is shown in Fig.6. Fig.6a indicates the global conversion rate various with the desorption temperature of 180 °C and 130 °C, respectively. It can be found that the higher desorption temperature is, the faster the global conversion rate varies due to the larger chemisorption potential. Also noting that the two desorption stages proceed on condition of the working temperature. It takes about 15 minutes to finish the reaction SrCl₂ 8-1 when the desorption temperature is 180°C. Comparably 40 minutes will be consumed when the desorption temperature is 130°C. The second stage SrCl₂ 1-0 will takes more time for 130°C desorption temperature. Fig.6 (b) indicates the global conversion rate on condition of the sorption temperature from -5°C to 15°C with 5°C increment, which only manifests the reaction SrCl₂ 1-8. It is indicated that the global conversion rate varies faster with the increase of the sorption temperature. When the global conversion is 0.7, it takes about 14 minutes for 15°C sorption temperature. It takes about 28 minutes even for the lowest sorption temperature of -5°C.

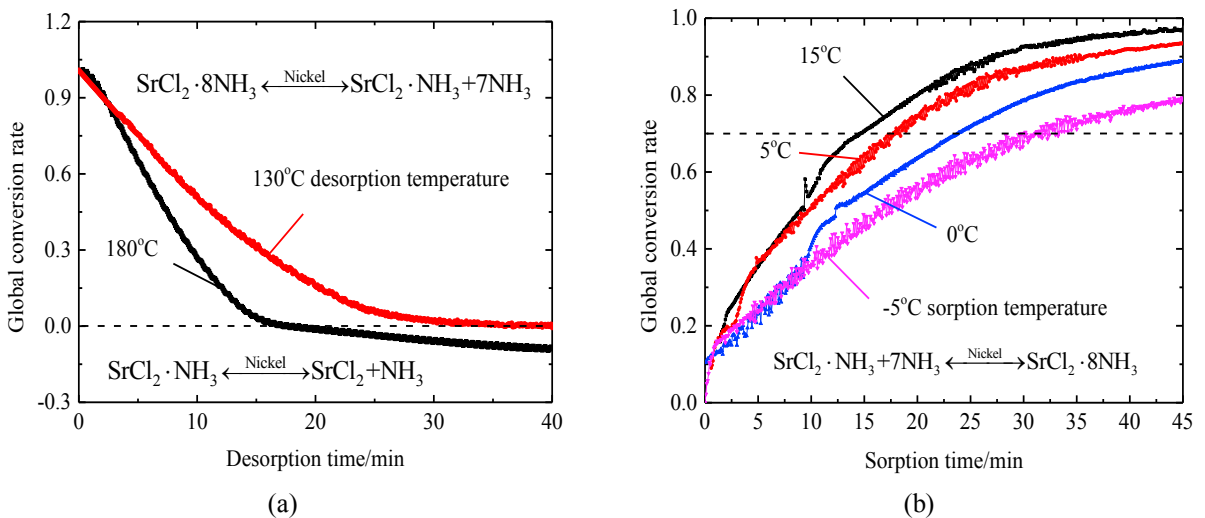

Fig. 6. Thermal conductivity for different density (a) desorption process; (b) sorption process

5 Conclusions

Novel SrCl₂ composite sorbents are developed, which is impregnated with ENG and carbon coated nickel as an additive. Thermal diffusivity, thermal conductivity and sorption characteristics are all tested and analyzed. The conclusions are yielded as follows:

- (1) Thermal diffusivity increases with the decrease of testing temperature and the increase of the density. The highest thermal diffusivity is able to reach 2.242 mm²·s⁻¹ when the density is 1000 kg·m⁻³ and testing temperature is 20°C. For different testing temperature and density, the thermal diffusivity range from 1.3 mm²·s⁻¹ to 2.242 mm²·s⁻¹.
- (2) The highest thermal conductivity could reach 1.345 W·m⁻¹·K⁻¹. For different density, the thermal conductivity range from 0.5 to 1.345 W·m⁻¹·K⁻¹ when the testing temperature is 20°C.
- (3) For the desorption kinetics, the higher desorption temperature is, the faster the global conversion rate varies. Also two desorption stages proceeds on condition of the working temperature. It takes about 15 minutes and 40 minutes to finish the reaction SrCl₂ 8-1 and 1-0 when the desorption temperature is 180°C and 130°C, respectively. For sorption kinetics, the global conversion rate varies faster with the increase of the sorption temperature. When the global conversion is 0.7, it takes about 14 minutes for 15°C sorption temperature. It takes about 28 minutes even for the lowest sorption temperature of -5°C.

For such a novel composite sorbent, heat transfer and sorption kinetics are both improved, which will be a great innovation for the sorption refrigeration. Under this scenario, the sorbent can greatly reduce the cycle time and lower the heat driving temperature. It is also worth noting that the system compactness will be increased, which plays an important role in the places of limited spaces.

Acknowledgements

This research was supported by the National Natural Science Foundation of China for general program (Grant No. 51606118) and for Innovative Research Groups (Grant No. 51521004) and IDRIST project (EP/M008088/1), Heat-STRESS (EP/N02155X/1) funded by the Engineering and Physical Science Research Council of the UK.

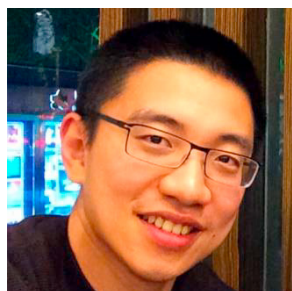

Biography

Dr Yiji Lu, born in June 1989, is currently a research associate in Newcastle University. He graduated from Shanghai Jiao Tong University in 2011 for his bachelor degree, he conducted his M.Phil. and Ph.D. in Newcastle University in 2012 and 2016. His Ph.D. program was fully sponsored by EPSRC and was awarded the '2015 Chinese Government Award for Outstanding Self-financed Students Abroad' from China Scholarship Council. His research interests include but not limited to advanced waste heat recovery technologies, engine thermal management, advanced engine development, engine emission technologies, chemisorption cycles and expansion machines for power generation system. He has been regularly invited to review the manuscripts for the scientific journals including Applied Energy, Applied Thermal Engineering, Energy (the International Journal), and Energy for Sustainable Development.

References

- [1] R.Z. Wang, X. Yu, T.S. Ge, T.X. Li, The present and future of residential refrigeration, power generation and energy storage, Applied Thermal Engineering, 53 (2013) 256-270.
- [2] A.P. Roskilly, P.C. Taylor, J. Yan, Energy storage systems for a low carbon future – in need of an integrated approach, Applied Energy, 137 (2015) 463-466.
- [3] Y. Lu, Y. Wang, H. Bao, L. Wang, Y. Yuan, A.P. Roskilly, Analysis of an optimal resorption cogeneration using mass and heat recovery processes, Applied Energy, 160 (2015) 892-901.

- [4] L. Jiang, L.W. Wang, R.Z. Wang, Investigation on thermal conductive consolidated composite CaCl₂ for adsorption refrigeration, *International Journal of Thermal Sciences*, 81 (2014) 68-75.
- [5] Y. Lu, A.P. Roskilly, K. Tang, Y. Wang, L. Jiang, Y. Yuan, L. Wang, Investigation and performance study of a dual-source chemisorption power generation cycle using scroll expander, *Applied Energy*, epub ahead of print (2017).
- [6] L. Jiang, L.W. Wang, Z.Q. Jin, R.Z. Wang, Y.J. Dai, Effective thermal conductivity and permeability of compact compound ammoniated salts in the adsorption/desorption process, *International Journal of Thermal Sciences*, 71 (2013) 103-110.
- [7] L. Jiang, Y. Lu, K. Tang, Y. Wang, R. Wang, A.P. Roskilly, L. Wang, Investigation on heat and mass transfer performance of novel composite strontium chloride for sorption reactors, *Applied Thermal Engineering*, 121 (2017) 410-418.
- [8] Z.S. Zhou, L.W. Wang, L. Jiang, P. Gao, R.Z. Wang, Non-equilibrium sorption performances for composite sorbents of chlorides–ammonia working pairs for refrigeration, *International Journal of Refrigeration*, 65 (2016) 60-68.
- [9] X. Py, E. Daguerre, D. Menard, Composites of expanded natural graphite and in situ prepared activated carbons, *Carbon*, 40 (2002) 1255-1265.
- [10] J.-h. Li, L.-l. Feng, Z.-x. Jia, Preparation of expanded graphite with 160 μm mesh of fine flake graphite, *Materials Letters*, 60 (2006) 746-749.
- [11] S. Mauran, P. Prades, F. L'Haridon, Heat and mass transfer in consolidated reacting beds for thermochemical systems, *Heat Recovery Systems and CHP*, 13 (1993) 315-319.
- [12] B. Tian, Z.Q. Jin, L.W. Wang, R.Z. Wang, Permeability and thermal conductivity of compact chemical and physical adsorbents with expanded natural graphite as host matrix, *International Journal of Heat and Mass Transfer*, 55 (2012) 4453-4459.
- [13] K. Wang, J.Y. Wu, R.Z. Wang, L.W. Wang, Effective thermal conductivity of expanded graphite–CaCl₂ composite adsorbent for chemical adsorption chillers, *Energy Conversion and Management*, 47 (2006) 1902-1912.
- [14] Z. Tamainot-Telto, R.E. Critoph, Monolithic carbon for sorption refrigeration and heat pump applications, *Applied Thermal Engineering*, 21 (2001) 37-52.
- [15] Z. Tamainot-Telto, R.E. Critoph, Advanced solid sorption air conditioning modules using monolithic carbon–ammonia pair, *Applied Thermal Engineering*, 23 (2003) 659-674.
- [16] L. Jiang, L.W. Wang, Z.Q. Jin, B. Tian, R.Z. Wang, Permeability and Thermal Conductivity of Compact Adsorbent of Salts for Sorption Refrigeration, *Journal of heat transfer ASME*, 134 (2012) 104503-104506.
- [17] L.W. Wang, Z. Tamainot-Telto, S.J. Metcalf, R.E. Critoph, R.Z. Wang, Anisotropic thermal conductivity and permeability of compacted expanded natural graphite, *Applied Thermal Engineering*, 30 (2010) 1805-1811.
- [18] F.B. Cortés, J.M. Mejía, M.A. Ruiz, P. Benjumea, D.B. Riffel, Sorption of asphaltenes onto nanoparticles of nickel oxide supported on nanoparticulated silica gel, *Energy & Fuels*, 26 (2012) 1725-1730.
- [19] C. Franco, E. Patiño, P. Benjumea, M.A. Ruiz, F.B. Cortés, Kinetic and thermodynamic equilibrium of asphaltenes sorption onto nanoparticles of nickel oxide supported on nanoparticulated alumina, *Fuel*, 105 (2013) 408-414.
- [20] C.A. Franco, N.N. Nassar, M.A. Ruiz, P. Pereira-Almao, F.B. Cortés, Nanoparticles for inhibition of asphaltenes damage: adsorption study and displacement test on porous media, *Energy & Fuels*, 27 (2013) 2899-2907.
- [21] M. Ahmadi, H. Elmongy, T. Madrakian, M. Abdel-Rehim, Nanomaterials as sorbents for sample preparation in bioanalysis: A review, *Analytica Chimica Acta*, 958 (2017) 1-21.
- [22] L.W. Wang, S.J. Metcalf, R.E. Critoph, R. Thorpe, Z. Tamainot-Telto, Development of thermal conductive consolidated activated carbon for adsorption refrigeration, *Carbon*, 50 (2012) 977-986.
- [23] Q. Wu, Y. Lu, K. Tang, W. Yaodong, T. Roskilly, H. Zhang, Experimental exploration of a novel chemisorption composite of SrCl₂-NEG adding with Carbon coated Ni, *Energy Procedia*, (2016).
- [24] Q. Wu, Y. Lu, K. Tang, Y. Wang, A.P. Roskilly, H. Zhang, Experimental Exploration of a Novel Chemisorption Composite of SrCl₂-NEG Adding with Carbon Coated Ni, *Energy Procedia*, 105 (2017) 4655-4660.
- [25] Y. Lu, A resorption cogeneration cycle for power and refrigeration, in: *Sir Joseph Swan Centre for Energy Research, University of Newcastle upon Tyne*, 2016, pp. 210.
- [26] T. Yan, R.Z. Wang, T.X. Li, L.W. Wang, I.T. Fred, A review of promising candidate reactions for chemical heat storage, *Renewable and Sustainable Energy Reviews*, 43 (2015) 13-31.