

Performance of a tubular machine driven by an external-combustion free piston engine

*N. J. Baker**, *R.M. Korbekandi**, *A. Sa. Jalal[†]*, *D. Wu**

** School of Engineering, Newcastle University, Newcastle upon Tyne, United Kingdom, [†] Mechatronics Engineering Department - Baghdad University, Iraq*

Keywords: Linear Machine, free piston engine, tubular machine.

Abstract

Free piston engines have the potential to offer a compact machine capable of delivering electrical power. In this paper, the design and modelling of a linear tubular generator is presented and used to investigate the effect of electrical machine design on engine performance. A cogging force reduction technique is presented and used as a case study to demonstrate the importance of integrated design.

1 Introduction

The heart of most small to medium sized combustion engines is a piston which expands due to the injection of heat energy to a working fluid. Conventionally, the reciprocating linear motion of the piston is converted to a continuous rotating motion via a crankshaft and the heat energy is derived from combustion within the cylinder. In a Free Piston Engine (FPE), there is no conversion to rotary motion and the mechanical load is linear and reciprocating. Potential advantages of this include increased thermal efficiency, reduced frictional loss, a physically compact design and the potential for a flexible compression ratio leading to improved performance at part load.

At larger machine powers, gas turbine engines, based on the Joule Cycle, are attractive as the continuous steady flow through the combustor avoids the temperature peaks associated with reciprocating engines and can naturally have lower emissions. The Joule cycle conventionally relies on the air being compressed in a rotary compressor, then fuel burnt at a constant pressure prior to expansion through a turbine back to atmospheric pressure. Gas turbines do not scale well to low power smaller machines, primarily as leakage around the turbine becomes dominant. To avoid this, at small engine sizes (5-10kW) it has been proposed to operate the Joule cycle using reciprocating cylinders and pistons in a free piston type arrangement, [1]. Most analysis of the FPE has been driven by engineers working on the thermodynamic and mechanical aspects and the electrical machine has been characterised by a simple linear damper.

This paper discusses the design and modelling of a tubular linear generator developed to extract electrical power from an external combustion free piston engine operating on the Joule Cycle. The authors have previously presented work on the development of the electrical machine [2], the effect of power converter on machine design [3] and the importance of end effects on engine performance [4]. A simplified representation of the electrical machine coupled to a full thermodynamic model is given in [5].

In this paper, magnetic equivalent circuit and finite element analysis models are coupled to a thermodynamic model of a Joule cycle FPE to give a fully integrated system model which is used to investigate the influence of a cogging reduction technique on overall FPE performance.

2 Tubular machine

The tubular linear synchronous permanent magnet machine topology studied here is a longitudinal flux machine, with magnets mounted on an oversized translator as shown in Figure 1. It is composed of a three phase, six slot /seven pole combination and equipped with a modular stator winding in which circumferential coils of each phase are located adjacent to each other. The flux path in the stator core back and translator pole pieces is three dimensional and so these components are made from soft magnetic composite material, whereas flux in the stator teeth is radial and circumferential, and so they are formed of axial laminations.

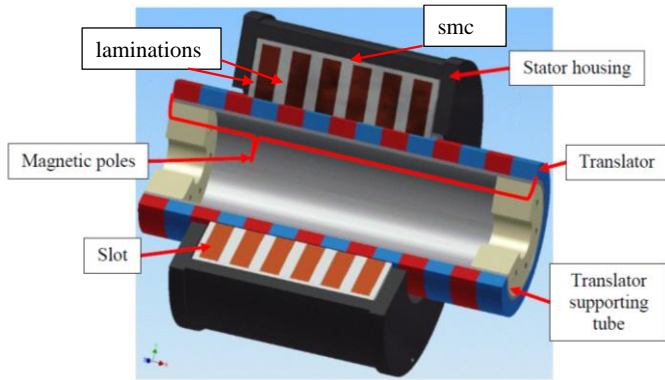

Figure 1: Electrical Machine topology

A design study [2] on the machine has investigated the dimensions defined in Figure 2 and the values of Table 1 are used for the design of a 3 kW machine.

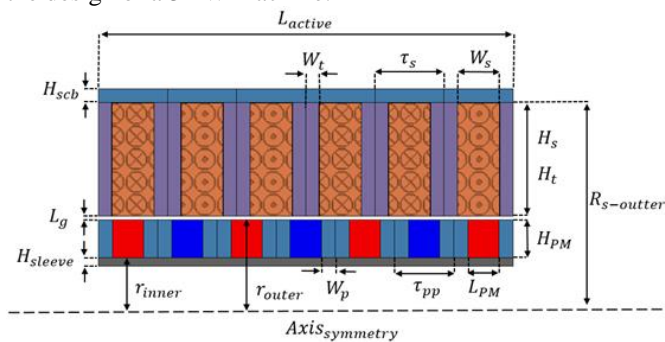

Figure 2: Geometrical parameter definition

Parameter		
r_{inner}	mm	39.5
r_{outer}	mm	51.5
$R_{s-outer}$	mm	86
L_p	mm	1.5
τ_{pp}	mm	17.1
L_{PM}	mm	8
H_{PM}	mm	12
W_s	mm	12.3
τ_s	mm	20
W_t	mm	3.9
W_p	mm	4.6
H_{scb}	mm	4
H_s	mm	33
Force	N	800
Stroke Length	mm	120
Peak Current Density	A/mm ²	6
B_r	T	1.08
μ_{rPM}		1.05

Table 1: Electrical Machine parameters

3 Thermodynamic Modelling of Free Piston Engine

The fundamental operation and performance of various FPEs has been extensively simulated and presented e.g. [6-8]. Expansion of this work includes combined electrical and dynamic performance using assorted simulation tools [9], [10] and numerical models [11]. In [12] a model of a Linear Joule Engine driving a simplified linear alternator was presented and used to propose an overall optimised system design. All these works have simplified the electrical machine to an ideal damper, where the alternator force varies linearly with velocity acting against engine's driving force. In terms of force, this is

effectively a simple ‘feed forward’ type model, where results from the thermodynamic model are simply past to the electrical machine model, see Figure 3 (a). There is no link between stator current, translator position and force felt by the engine.

In electrical terms, this assumption means the machine inductance is ignored, the electrical load is purely resistive and there is no force ripple. Whilst this may be applicable to a constant velocity generator, where inductance can be tuned out with a capacitive load, the variable velocity operation of the FPE gives a variable electrical frequency where no capacitive tuning can be implemented. In addition, a pure damper includes no effects of the combined electromagnetic forces, machine losses, and variation of these parameters to the overall FPE system.

As the electric machine is coupled directly to the piston-moving rod, there is flexibility for the designer to fit the system into limited volumetric envelopes. However, removal of the rotating inertia provided by the crank means the engine is sensitive to the force ripple of the electric machine, potentially impacting the thermodynamic efficiency. An initial study of the effect of cogging on system efficiency was presented in [4]. The model is still ‘feed forward’, Figure 3 (b), as the force from the generator did not alter the displacement profile of the machine, but improved electrical machine modelling based on FEA allowed the effect of inductance and force ripple to be investigated.

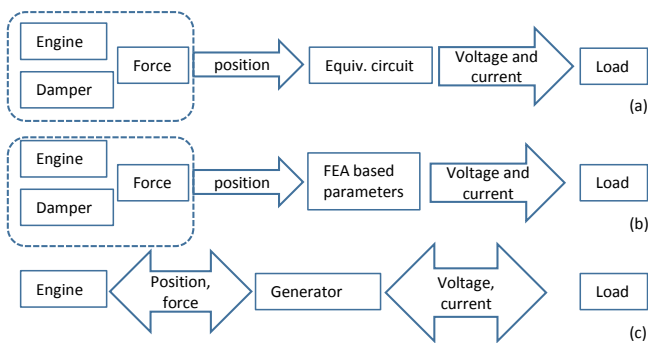

Figure 3: Modelling of free piston engines. (a) simple feed forward model; (b) more accurate electrical machine; (c) fully integrated modelling.

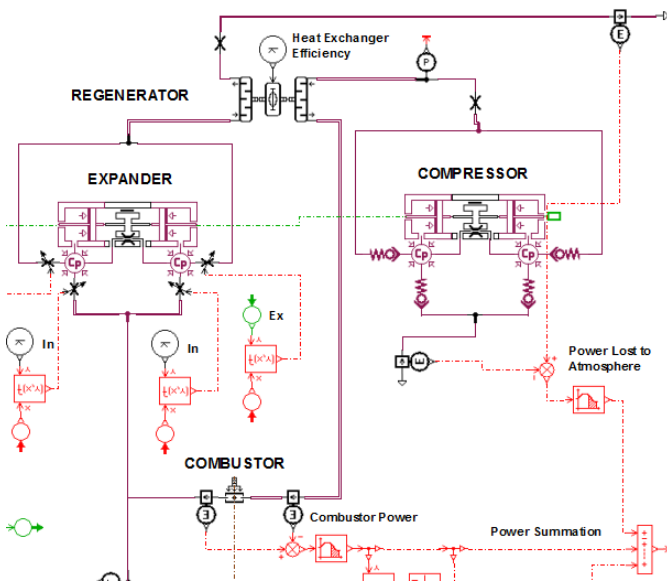

Figure 4: The thermodynamic part of the full free piston engine system model.

A full thermodynamic model, as presented in [13], has been implemented in AMESim from LMS Imagine software. It is here integrated into the electrical machine model to give the system model shown in Figure 3 (c). The electrical machine force, which is now a function of position, velocity and current, is directly fed back into the thermodynamic model of the engine. The parameters of the electrical machine model can either be derived from a finite element analysis model, an equivalent circuit model or an analytical machine model. And extract of the thermodynamic part of the model is shown in Figure 4.

4 Modelling a cylindrical linear machine

4.1 Reluctance Network

Different model approaches for electromagnetic characterisation of PMSM can be employed to observe the electrical machine behaviour. A full numerical model approach, based on finite element analysis (FEA) is very accurate and can be used for evaluation of electromagnetic devices. However, its disadvantage is the significant computational time. On the other hand, the analytic model approach, which solves the Maxwell equations, is a powerful approach for machine analysis, despite the fact that it is very complex. Although a short computational time is required in this approach, the net results are not accurate due to ignoring magnetic saturation of iron core, slot effects and end effects. To overcome these issues, slot effects can be considered by Carter’s coefficient, air-gap permeance function and virtual equivalent magnetizing current. As a result, the authors in this paper have employed a magnetic equivalent circuit or lumped model approach to model the electrical machine which is a compromise between accuracy and computational time and it is considered as a useful method for optimisation of the entire free piston engine system.

In order to make a fully integrated analytical model of the entire free piston engine system, a magnetic circuit model of the linear alternator is derived by modelling PM poles, stator geometry and airgap reluctances, as commonly performed e.g. [14, 15]. The following assumptions have been made:

- Due to symmetry, one pole pair pitch has been modelled which spans 360° electrical degrees.
- A constant magnetic flux density, magnetic field intensity and relative magnetic permeability are assumed in every point of the flux path in a single component.
- The magnetic path consists of an smc of translator pole piece, and smc of stator coreback and a steel lamination of the stator.
- Leakage flux and fringing flux are assumed to be negligible.
- Armature reaction flux is assumed to be negligible.

Many parts of the tubular machine can be represented by axial and circumferential flux through hollow cylinders, as defined in Figure 5. The reluctances are defined in Equation (1) and (2) respectively.

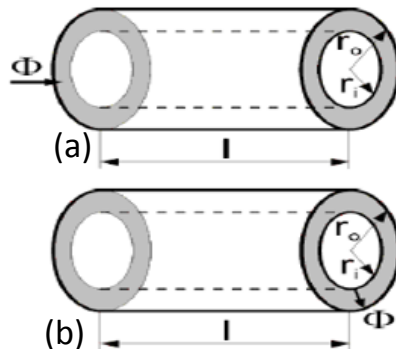

Figure 5: (a) axial and (b) radial flux flow through a hollow cylinder.

$$R = \frac{L}{\mu_0 \mu_r A} \tag{1}$$

$$R = \frac{\ln(\frac{r_o}{r_i})}{\mu_0 \mu_r 2\pi L} \tag{2}$$

Representative finite element analysis results were used to estimate the magnetic permeability of the laminations, stator coreback and translator pole pieces, as given in Table 2.

Material	Typical flux density (T)	Relative permeability
Stator teeth (laminated steel)	1.15	6100
Stator core (SMC)	1.17	350
Translator pole piece (SMC)	1.2	320

Table 2: Assumed permeability of machine components

Due to a small value of the MMF of the excitation winding in comparison with the permanent magnet’s MMF, its effect has been neglected. A schematic of the magnetic equivalent circuit of a single pole pair is illustrated in Figure 6, including reluctances of the components listed in Table 2, airgaps and the permanent magnets.

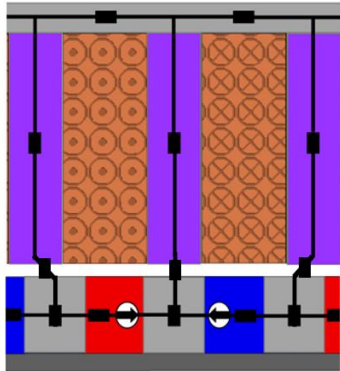

Figure 6: Reluctance network of a single pole pair

Peak distribution of flux density in the airgap from finite element analysis is found to be around 3.1 mWb. However, based on the simple magnetic equivalent circuit presented here, which assumes negligible leakage, fringing flux and armature reaction, the peak air gap flux density is 3.8 mWb. The equivalent circuit hence overestimates the FEA prediction by 18 percent. A similar agreement was found for inductance with low values of current.

4.2 Equivalent electrical circuit

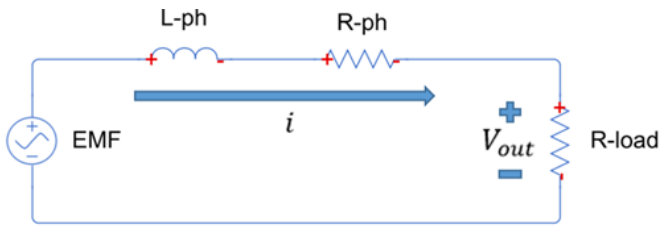

Figure 7: Equivalent per phase electrical circuit

Figure 7 shows the equivalent electrical circuit for a single phase of the tubular machine. The emf and inductance are derived from the reluctance network and the resistance is calculated from the machine geometry. The instantaneous current is a function of translator speed, translator position and the load resistance. It is found for a given time instant by solving Equation (3).

$$\frac{di}{dt} = \frac{1}{L} [E - R * i] \quad (3)$$

5 Generator forces

5.1 Force calculation

At present, this model uses sinusoidal approximations to results observed in finite element analysis to compute the electrical machine forces, although it is certainly possible to derive it from a reluctance network. The total force from the electrical machine is assumed to be the sum of its constituent parts due to cogging, armature reaction and losses.

The cogging force is defined as the force which acts to align the permanent magnet and the teeth. In simple words, the cogging force is due to the magnetic attraction between the permanent magnet mounted onto the shaft and the stator teeth and naturally pulls the machine to the position of lowest reluctance for the PMs.

5.2 Cogging force reduction

Cogging force is a known feature of many PM machines, and its reduction, for example by skewing, can often come at the expense of a loss in performance of an electrical machine. On a system level, therefore, it is not obvious if cogging force

reduction techniques give a net benefit to engine performance. An investigation of cogging force reduction is used as a case study here to demonstrate the integrated model of the FPE developed.

In this machine, cogging force is a combination of the slotting and end effects. Figure 8 shows a flux plot of the unloaded machine. It can be seen that flux lines spread across the outer teeth at each end of the stator due to the flux leaking from the inactive magnetic translator poles that are close to, but not enclosed by, the stator. At both ends, these flux lines spread over the side face of the end tooth starting from its bottom (tip) with density decreasing towards the top of the tooth. The force from both ends of the stator is attractive, and the resultant of the two varies with translator position, manifesting itself as the major part of the observed cogging force. There is an additional smaller force associated with slotting. To significantly reduce cogging force, therefore, the end effects must be reduced.

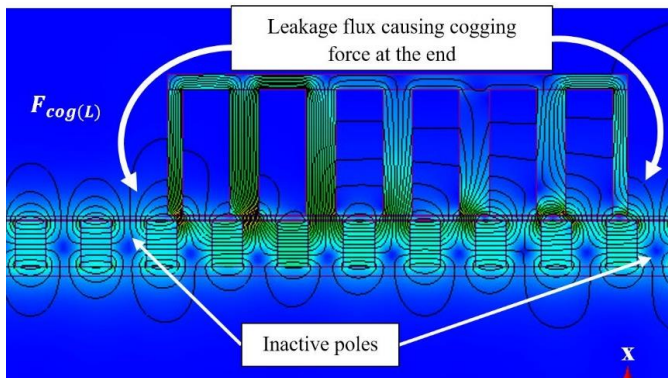

Figure 8: Flux plot showing end effect

It was found that addition of a Flux Gathering Ring (FGR) to the outer stator teeth, as shown in Figure 9, could be used as a simple but effective method of reducing the end effect. The reduction in resultant cogging is clearly shown in Figure 10. The impact of the FGR is used as a case study to use the full FPE system model.

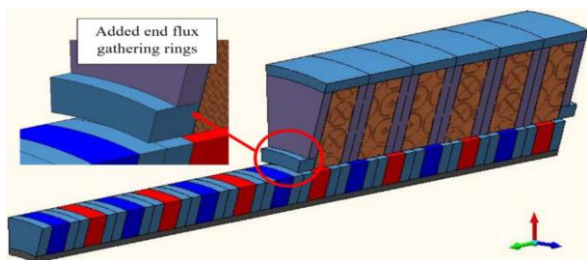

Figure 9: Flux Gathering Ring (FGR)

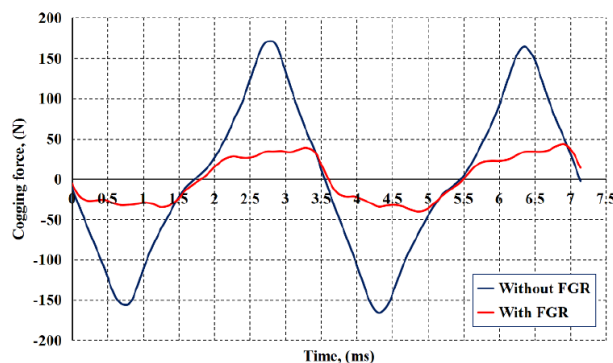

Figure 10: Finite element analysis cogging force predictions with and without the Flux Gathering Ring (FGR)

5.3 Force Validation

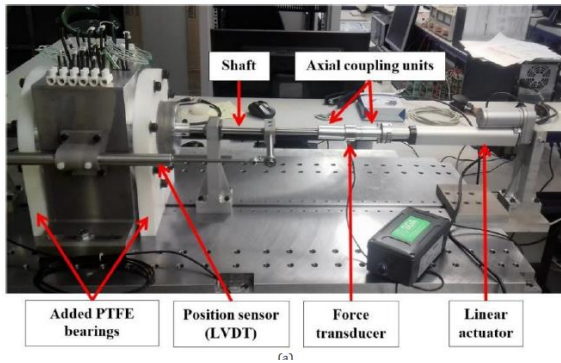

Figure 11: Laboratory experimental setup of testing the linear machine.

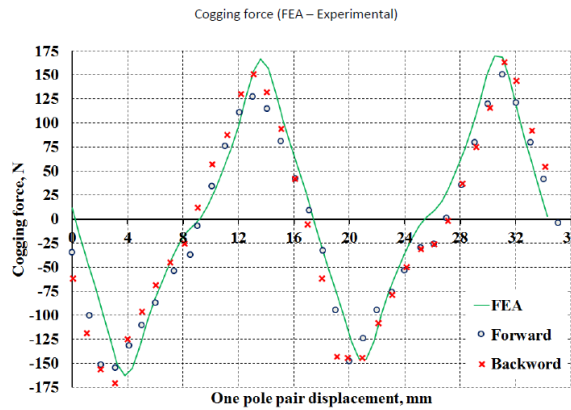

Figure 12: Predicted and measured cogging force

Figure 11 shows the experimentally measured and finite element analysis predicted values of no load cogging of a laboratory prototype machine without the FGR. Full details of the machine testing are given in [14].

6 Engine performance case study

The fully coupled electrical machine and thermodynamic model is implemented in LMS AMESim and used to investigate the significance of cogging on the predicted output power of the FPE. Two scenarios are investigated: Case I, a low cogging machine, assuming the FGRs of Figure 13 are installed and; Case II a higher cogging machine of 170N peak and represents the machine built and demonstrated in Figure 11 and Figure 12.

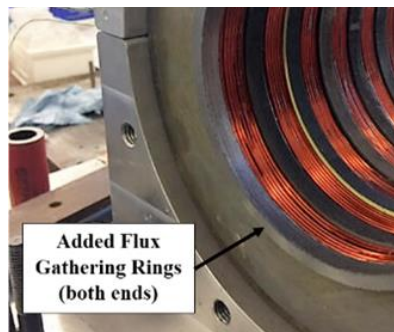

Figure 13: Low cogging machine stator with Flux Gathering Rings (FGR)

The electrical machine output force versus time over a full mechanical engine cycle is shown with and without FGR in Figure 14. Unsurprisingly, reduction of the ripple by use of FGR is directly visible in the active machine output force. The aim of this work is to look at the importance of that effect in the electrical power output. As shown in Figure 15, reduction of the cogging force clearly smooths the electrical power output of the system.

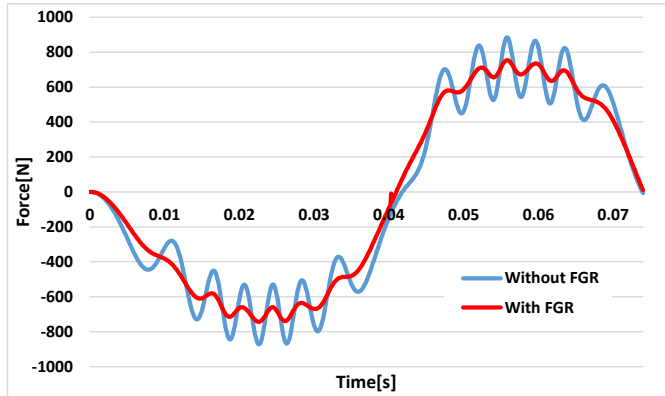

Figure 14: Predicted Electrical machine output force with and without Flux Gathering Rings (FGR)

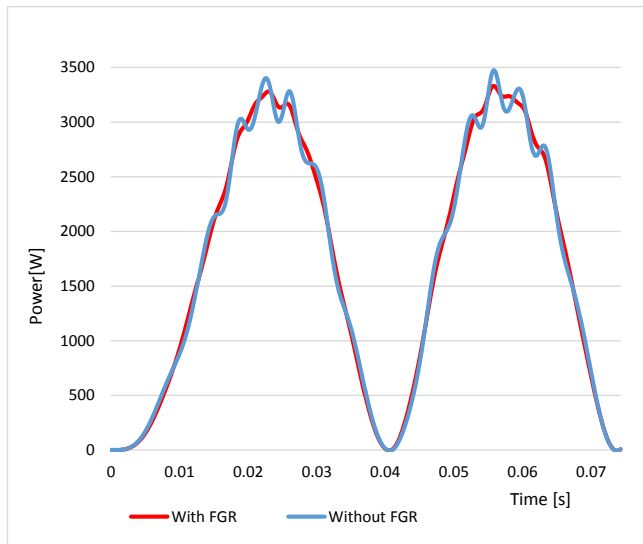

Figure 15: Predicted electrical power output with and without Flux Gathering Rings (FGR)

	Low cogging (with FGR)	Original cogging (No FGR)
Peak power (kW)	3.3	3.5
RMS power (kW)	2.1	2.1

Table 3: Summarised electrical power output with and without cogging reduction techniques

Peak and RMS values of output power are given in Table 3. The RMS output power is shown to be the same for both electrical machines. Perhaps the cogging reduction technique applied does not improve overall system efficiency, although it clearly helps with power smoothing.

7 Conclusion

The development of a fully integrated thermodynamic and electrical machine model of a free piston engine has been presented. It is used to investigate the importance of a cogging force reduction technique on the electrical output power. The flux gathering ring is shown to smooth out the electrical power output from the free piston engine, but does not alter the RMS power of the system.

References

- [1] R. W. Moss, A. P. Roskilly, and S. K. Nanda, "Reciprocating Joule-cycle engine for domestic CHP systems," *Applied Energy*, vol. 80, pp. 169-185, 2005.
- [2] Aslan Sa. Jalal, Nick J. Baker and Dawei Wu, "Design of tubular moving magnet linear alternator for use with an external combustion - free piston engine". *8th IET Int. Conf. on Pwr Elctrncs, Mchns and Drvs* (PEMD 2016), Glasgow, UK, 2016.
- [3] Aslan Sa. Jalal, Nick J. Baker and Dawei Wu, "The effect of power converter on the design of a Linear Alternator for use with a Joule Cycle-Free Piston Engine," *IEEE Int. Elec. Mchns and Drvs Conf (IEMDC2017)*, Miami, Florida USA, 2017.
- [4] Aslan Sa. Jalal, Nick J. Baker and Dawei Wu, "Electrical Machine Design for use in an External Combustion Free Piston Engine," *The 5th IET Int. Conf. on Ren. Power Gen (RPG)*, London, UK, 2016.
- [5] D. Wu and A. P. Roskilly, "Design and Parametric Analysis of Linear Joule-cycle Engine with Out-of-cylinder Combustion," *Energy Procedia*, vol. 61, pp. 1111-1114, 2014.
- [6] R. Mikalsen and A. P. Roskilly, "The design and simulation of a two-stroke free-piston compression ignition engine for electrical power generation," *Applied Thermal Engineering*, vol. 28, pp. 589-600, April 2008.
- [7] R. Mikalsen and A. P. Roskilly, "Performance simulation of a spark ignited free-piston engine generator," *Applied Thermal Engineering*, vol. 28, pp. 1726-1733, 10// 2008.
- [8] R. Mikalsen and A. P. Roskilly, "A computational study of free-piston diesel engine combustion," *Applied Energy*, vol. 86, pp. 1137-1143, 2009.
- [9] S. M. A. Sufian, K. A. Sagar, M. A. Ullah, and D. Baidya, "Harvesting electrical power from waste heat using stirling engine," in *Strategic Technology (IFOST)*, 2014 9th International Forum on, 2014, pp. 343-346.
- [10] K. L. x00Fc, tt, and M. Lehtonen, "Automotive waste heat harvesting for electricity generation using thermoelectric systems — An overview," in *2015 IEEE 5th Int. Conf on Power Enging, Energy and Elec Drives (POWERENG)*, 2015, pp. 55-62.
- [11] R. Mikalsen and A. P. Roskilly, "A review of free-piston engine history and applications," *Applied Thermal Engineering*, vol. 27, pp. 2339-2352, October 2007.
- [12] D. Wu and A. P. Roskilly, "Design and Parametric Analysis of Linear Joule-cycle Engine with Out-of-cylinder Combustion," *Energy Procedia*, vol. 61, pp. 1111-1114, 2014.
- [13] D. Wu, Aslan Sa Jalal, Nick Baker, "A coupled model of the Linear Joule Engine with embedded tubular permanent magnet linear alternator", *Energy Procedia* 105 (2017) 1986 – 1991
- [14] M. Rahman, T. Little, and G. Slemon, "Analytical models for interior-type permanent magnet synchronous motors," *IEEE Trans. on Magn*, vol. 21, no. 5, pp. 1741-1743, 1985.
- [15] C. Yaow-Ming, F. Shu-Yuan, and L. Wei-Shin, "Performance analysis of linear permanent magnet motors for optimal design considerations," in *Appld Pwr Electr. Conf. and Exp.*, 2004. APEC '04. Nineteenth Annual IEEE, 2004, vol. 3, pp. 1584-1589 Vol.3
- [14] N.J.Baker, A. Sa. Jalal, J. Wang Experimental comparison of two linear machines developed for a free piston engine. *9th IET Int. Conf. on Pwr Elctrncs, Mchns and Drvs* PEMD 2018 (submitted)